

INSIGNIA™

Quick-Setup Glass and Metal TV Stand

NS-MG1158



SAFETY INFORMATION AND SPECIFICATIONS....	2
PACKAGE CONTENTS: PARTS.....	3
PACKAGE CONTENTS: HARDWARE.....	4
ASSEMBLY INSTRUCTIONS.....	5
CARE AND MAINTENANCE.....	11

Before using your new product, please read these instructions to prevent any damage.

INSIGNIA™

QUICK-SETUP GLASS AND METAL TV STAND

SAFETY INFORMATION AND SPECIFICATIONS



CAUTION: The top surface of this stand is designed for use with a product weighing no more than 300 lbs. (136 kg) and having a width that permits it to sit evenly on the stand with no more than a one-inch overhang on each side of the shelf. Use with products that weigh more than the maximum weight allowed, or with dimensions that extend beyond the maximum width may result in instability, which may result in injury.



CAUTION: This product contains small items that could be a choking hazard if swallowed. Keep these items away from young children!

Model #: NS-MG1158

Maximum weight: 300 lbs. (136 kg)
Maximum width: 1-inch overhang on each side of the top shelf

Overall dimensions (W x H x D):

58 x 24 x 20" (147.32 x 60.96 x 50.8 cm)

Top shelf (W x D):

58 x 20" (147.32 x 50.8 cm)

Middle shelf (W x H x D):

48.75 x 10 x 18" (123.82 x 24.5 x 45.72 cm)

Bottom shelf (W x H x D):

42.75 x 10.13 x 17.13" (108.58 x 25.73 x 43.51 cm)

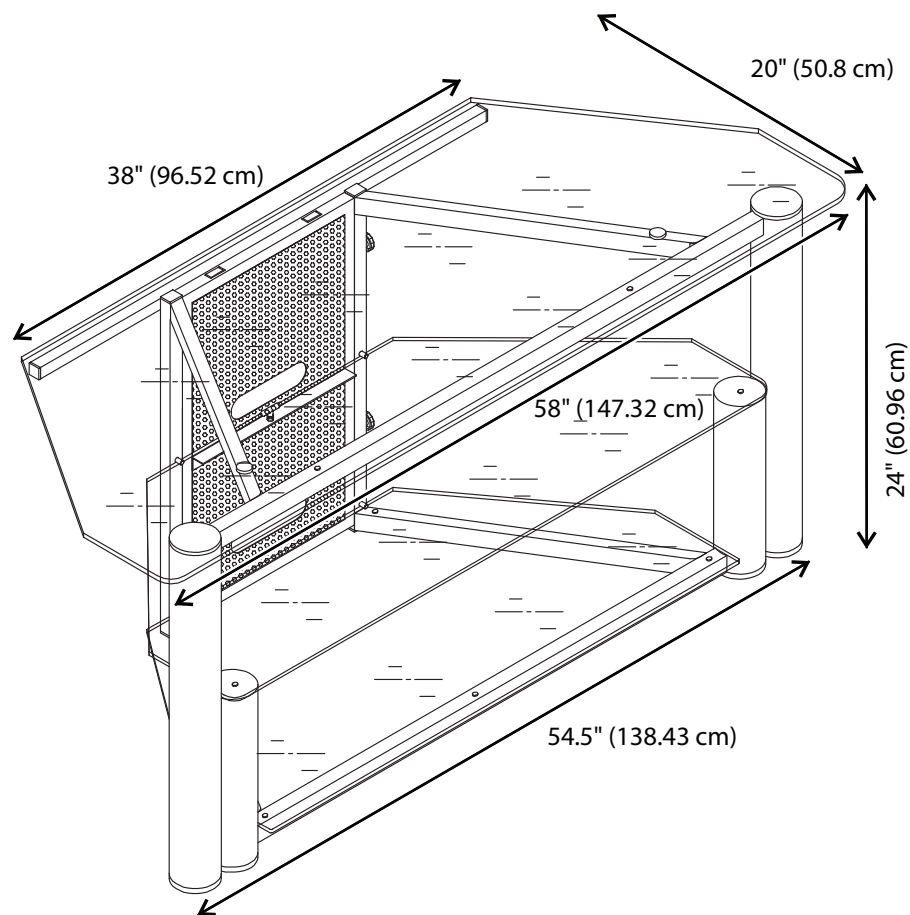

Tools needed:



Phillips screwdriver

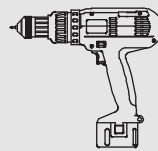

Drill



QUICK-SETUP GLASS AND METAL TV STAND

INSIGNIA™

PACKAGE CONTENTS: PARTS

A Stand body(1)

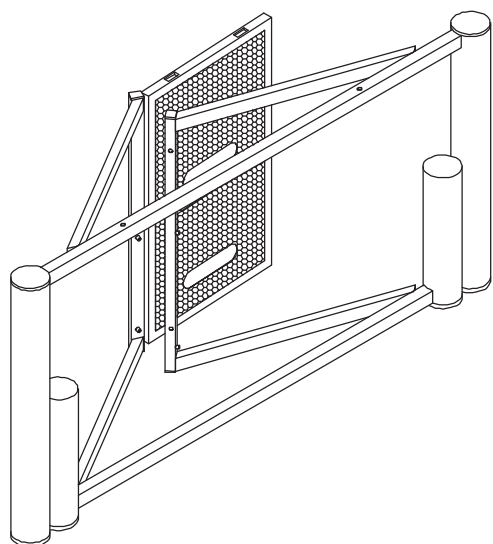

C Middle glass shelf (1)

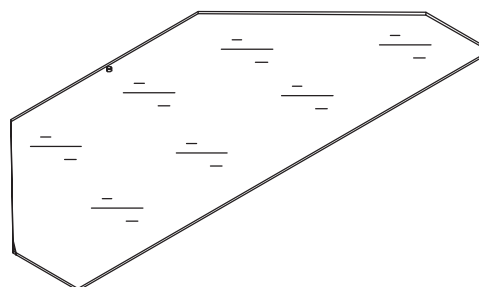

D Bottom glass shelf (1)

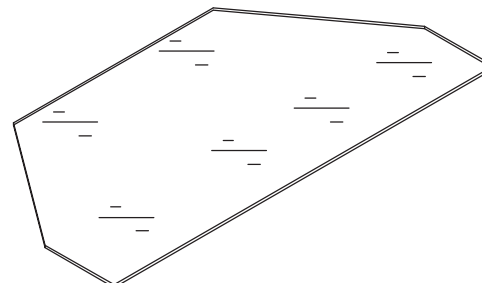

B Top glass shelf (1)

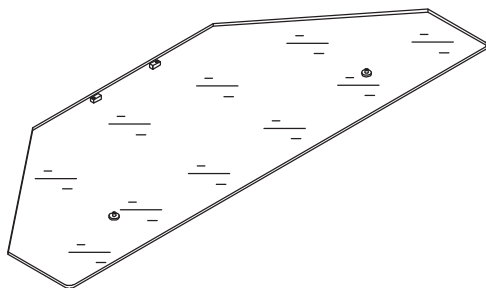

J Rear support bar (1)

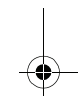
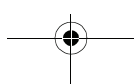
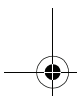
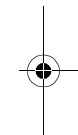
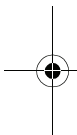
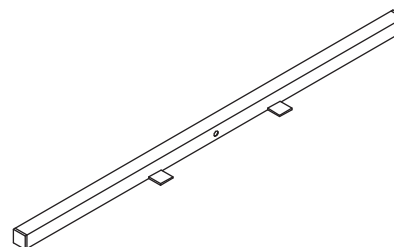



INSIGNIA™



QUICK-SETUP GLASS AND METAL TV STAND

PACKAGE CONTENTS: HARDWARE

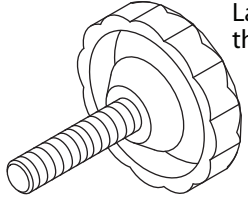
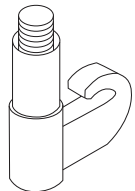
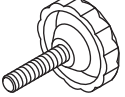
Note: You may receive extra hardware.

Make sure you have all the hardware necessary to assemble your new TV stand:

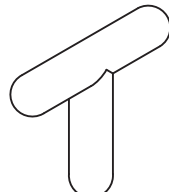
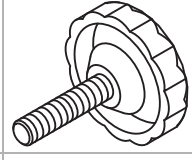
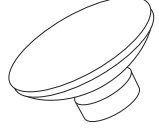
Label	Hardware	Qty.
E	 Large thumbscrew	2
F	 Locking peg	2
G	 Small thumbscrew	2
H	 Rubber pad	2

Label	Hardware	Qty.
I	 T-shaped shelf lock	1
K	 Medium thumbscrew	1
L	 Large suction cups	2
M	 Small suction cups	3

An optional anti-tipping hardware kit is included. Instructions on how to install the hardware are included on the bag containing the kit.

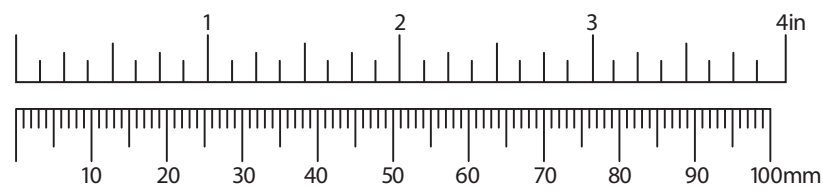



QUICK-SETUP GLASS AND METAL TV STAND

INSIGNIA™

ASSEMBLY INSTRUCTIONS

Step 1: Unfolding the stand body.

- Unfold the stand body (A), then insert and tighten two large thumbscrews (E) into the right side of the rear panel.

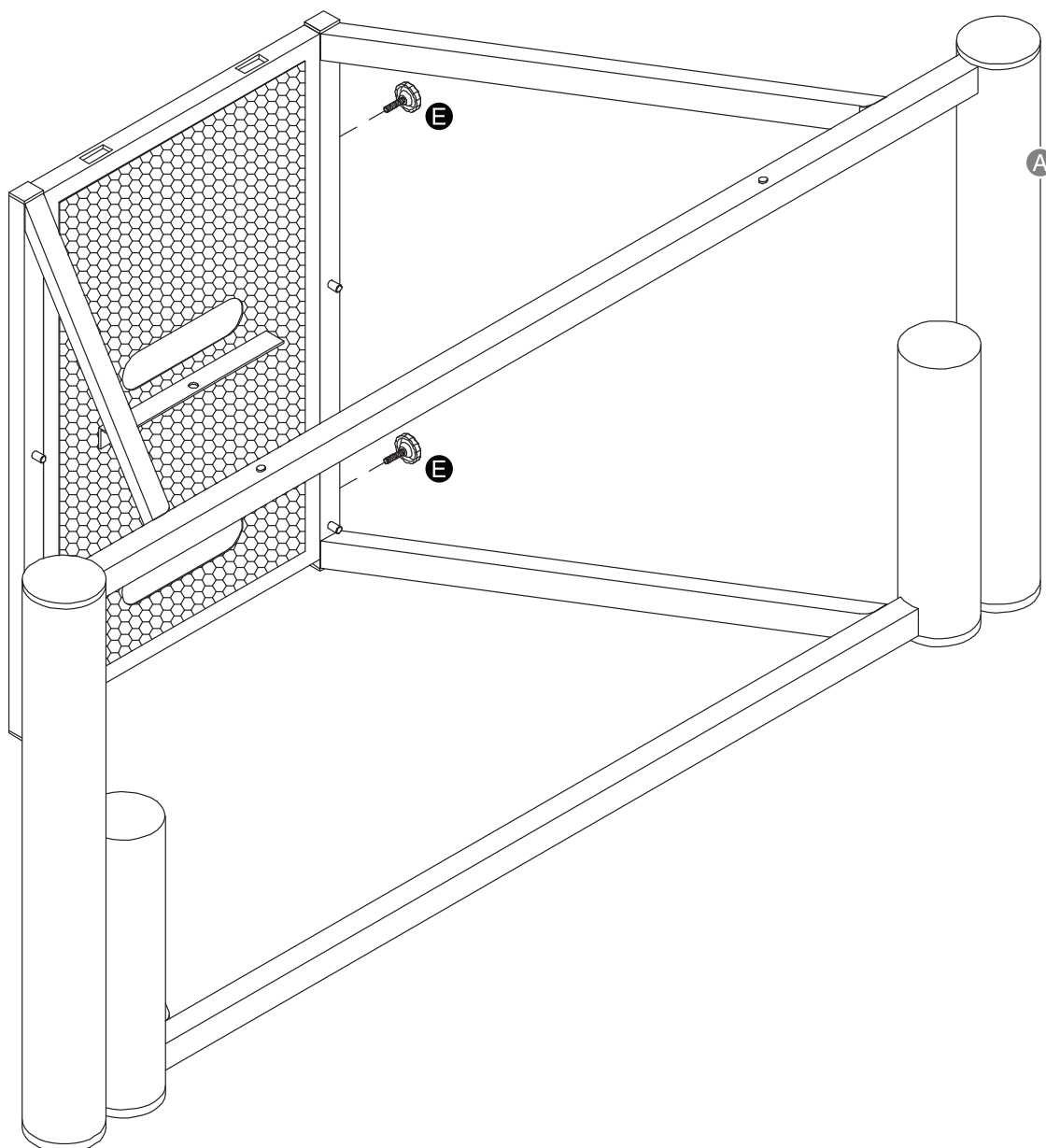

You'll need:

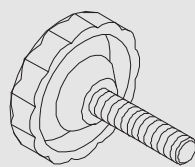

E (2)

INSIGNIA™

QUICK-SETUP GLASS AND METAL TV STAND

Step 2: Attach the rear support bar

- 1 Attach the rear support bar (**J**) to the top metal frame with the medium thumbscrew (**K**).
- 2 Insert the two locking pegs (**F**) into the bottom side of the top glass shelf (**B**).

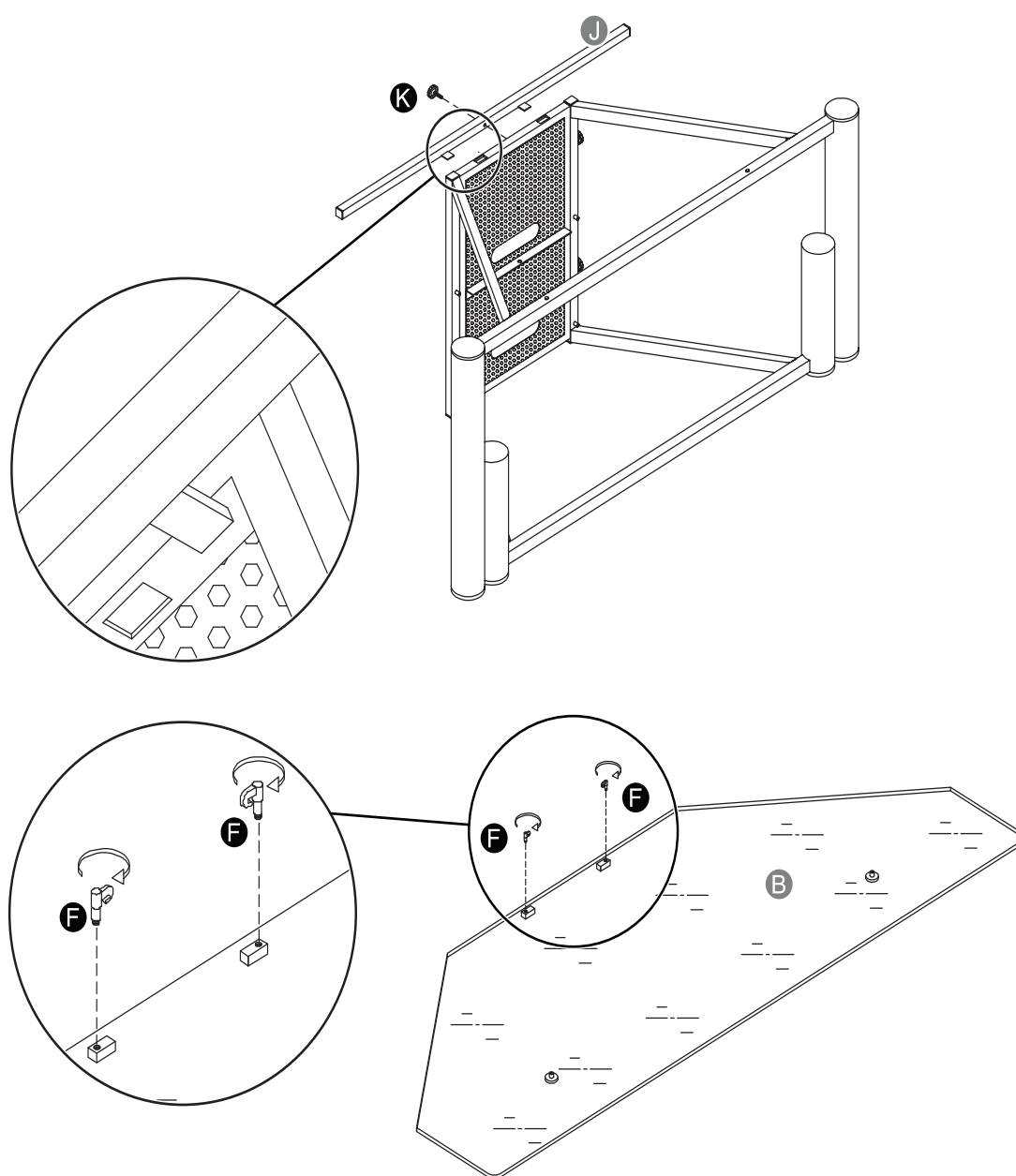

You'll need:

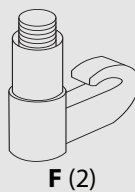
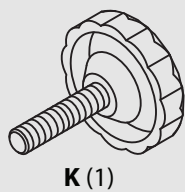

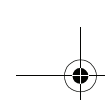

QUICK-SETUP GLASS AND METAL TV STAND

INSIGNIA™

Step 3: Mounting the top shelf

- Turn the top shelf over and align the locking pegs with the holes in the top of the back support frame and align the metal pegs with holes in the side of the frame. Lock the locking pegs in place by rotating the peg heads to face the back.

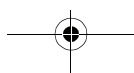
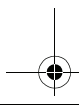
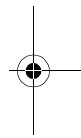
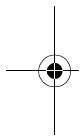
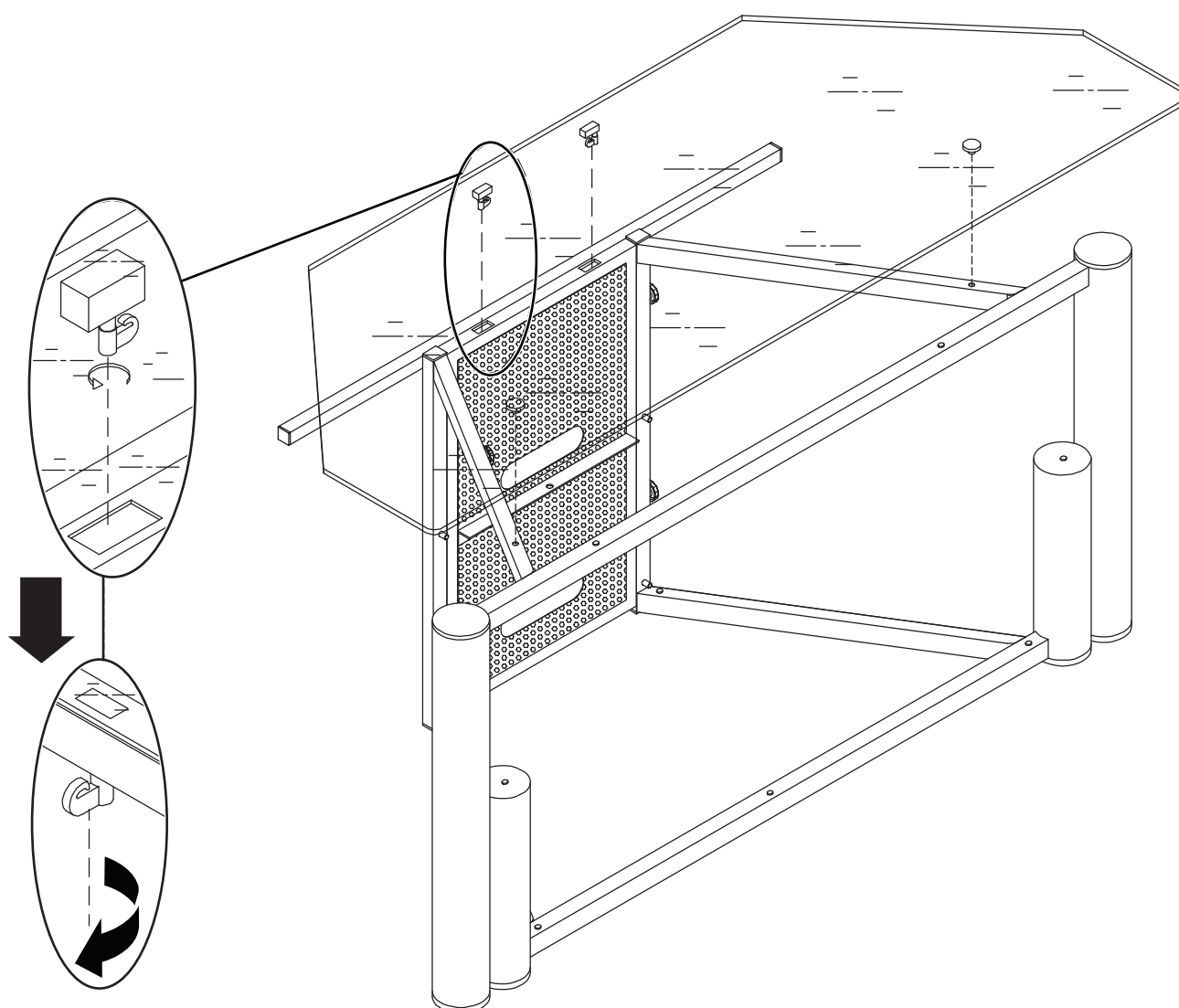

INSIGNIA™

QUICK-SETUP GLASS AND METAL TV STAND

Step 4: Securing the top shelf

- 1 Secure the top shelf to the steel frame with the small thumbscrews (**G**) and attach two rubber shelf pads (**H**).
- 2 Insert two large suction cups (**L**) and three small suction cups (**M**).

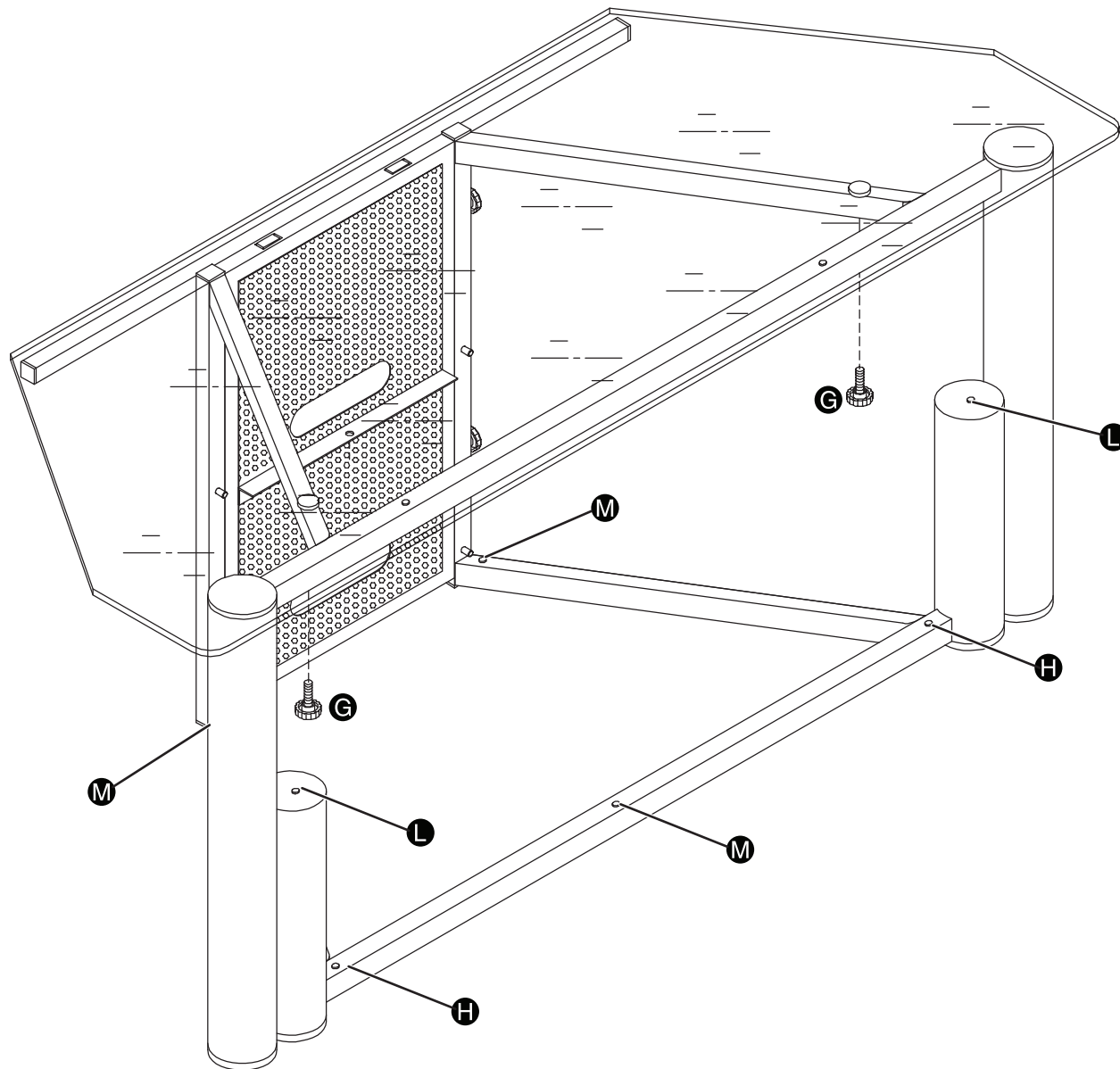

You'll need:

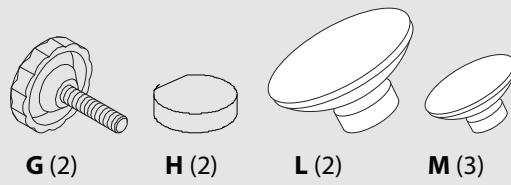

QUICK-SETUP GLASS AND METAL TV STAND

INSIGNIA™

Step 5: Installing the middle and bottom shelves

- Install the remaining shelves (C and D). Lock the middle shelf (C) into place with the T-shaped shelf lock (I).

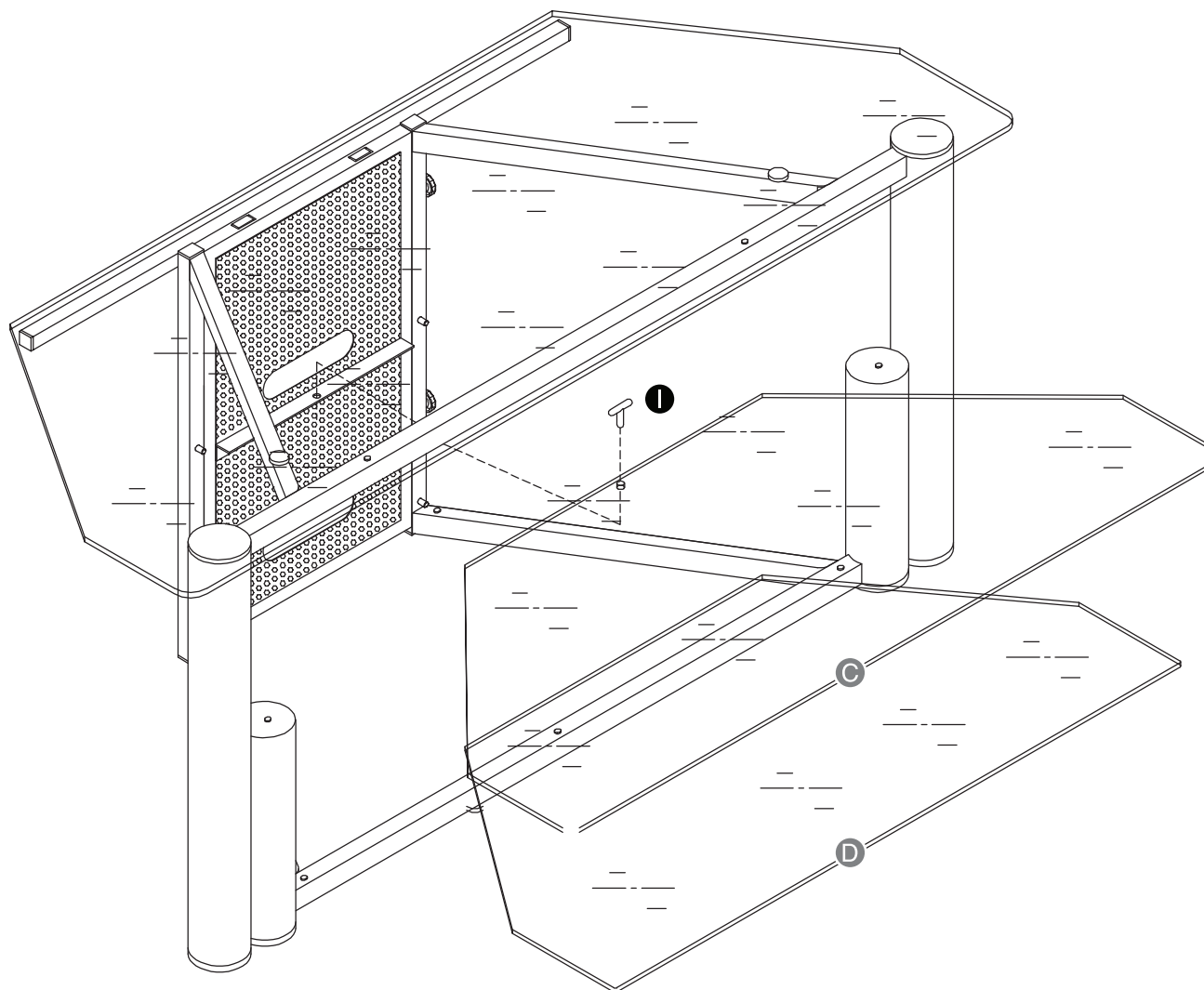

You'll need:

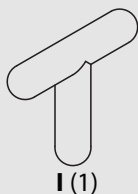

INSIGNIA™

QUICK-SETUP GLASS AND METAL TV STAND

Step 6: Installing the optional tipping restraint

- Install the tipping restraint hardware by removing the top thumbscrew, placing the loop on the tipping restraint over the thumbnail screw hole, then replacing the thumbscrew.

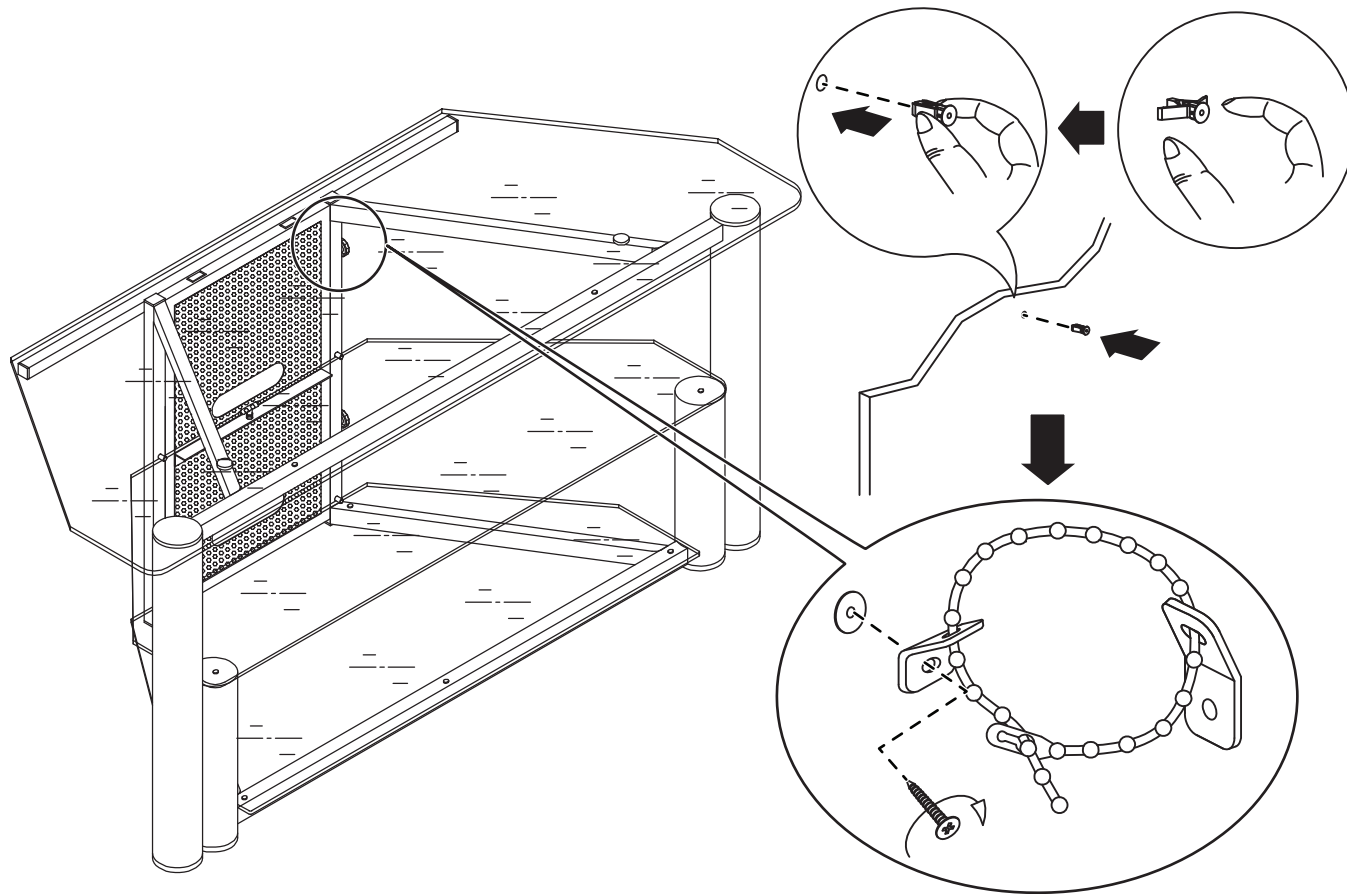

You'll need:

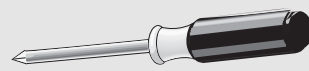

Phillips screwdriver

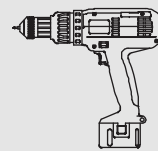

Drill

QUICK-SETUP GLASS AND METAL TV STAND

INSIGNIA™

CARE AND MAINTENANCE

Glass

- Use a commercial liquid glass cleaner and a soft cloth.
- Do not use harsh powders or any other abrasive substances as they will scratch the glass.

WARNING

Please use your stand correctly and safely. Improper use can cause safety hazards or damage to your furniture or household items. Carefully read the following chart.

Look out for:	What can happen:	How to avoid the problem:
<ul style="list-style-type: none"> • Children climbing on the stand. • A child may try to reach a toy or other object by climbing on the stand. • Children will play and be active near the TV. 	<ul style="list-style-type: none"> • Risk of injury or death. • A child climbing on the stand can make it top-heavy and cause it to tip over. • A child playing with a TV can cause it to tip over. 	<ul style="list-style-type: none"> • Never allow children to climb on or play with the stand. • Do not place toys or food on the top shelves. Children may try to climb to reach them out of curiosity.
<ul style="list-style-type: none"> • Improper use of the stand to support TVs. • The stand is designed for use with TVs will specify the maximum weight rating and recommended size of the TVs it will safely support. 	<ul style="list-style-type: none"> • Risk of injury or death. • TVs can be very heavy. Note, older CRT TVs tend to be unbalanced and prone to tipping forward. 	<ul style="list-style-type: none"> • A TV must only be set on furniture specifically designed to support a television. • Never use a TV that exceeds the weight ratings or size guidelines specified for the stand.
<ul style="list-style-type: none"> • Overloaded shelves 	<ul style="list-style-type: none"> • Risk of injury. • Top-heavy furniture can tip over. • Overloaded shelves can break. 	<ul style="list-style-type: none"> • Never exceed the weight limits shown in the instructions. • Work from the bottom to the top when loading shelves. • The bottom shelves can only support 95 lbs. while the top can support 300 lbs.
<ul style="list-style-type: none"> • Improperly moving the stand. 	<ul style="list-style-type: none"> • The stand can tip over or break if improperly moved. • Risk of injury. 	<ul style="list-style-type: none"> • Unload shelves from the top to the bottom before moving the stand. • Do not push the stand, especially on a carpeted floor. Have a friend help you lift the item and set it in place. • Do not lift the stand using the top shelf. Lift from the frame or leg assembly. • Remove the TV before moving the TV stand.

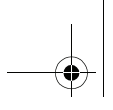

INSIGNIA™

QUICK-SETUP GLASS AND METAL TV STAND

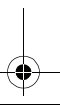
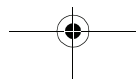
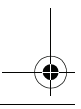
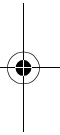
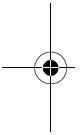

QUICK-SETUP GLASS AND METAL TV STAND

INSIGNIA™

ONE-YEAR LIMITED WARRANTY - INSIGNIA

Definitions:

The Distributor* of Insignia branded products warrants to you, the original purchaser of this new Insignia-branded product ("Product"), that the Product shall be free of defects in the original manufacturer of the material or workmanship for a period of one (1) year from the date of your purchase of the Product ("Warranty Period").

For this warranty to apply, your Product must be purchased in the United States or Canada from a Best Buy branded or Future Shop branded retail store or online at www.bestbuy.com, www.bestbuy.ca, or www.futureshop.ca and is packaged with this warranty statement.

How long does the coverage last?

The Warranty Period lasts for 1 year (365 days) from the date you purchased the Product. Your purchase date is printed on the receipt you received with the Product.

What does this warranty cover?

During the Warranty Period, if the original manufacture of the material or workmanship of the Product is determined to be defective by an authorized Insignia repair center or store personnel, Insignia will (at its sole option): (1) repair the Product with new or rebuilt parts; or (2) replace the Product at no charge with new or rebuilt comparable products or parts. Products and parts replaced under this warranty become the property of Insignia and are not returned to you. If service of Products or parts are required after the Warranty Period expires, you must pay all labor and parts charges. This warranty lasts as long as you own your Insignia Product during the Warranty Period. Warranty coverage terminates if you sell or otherwise transfer the Product.

How to obtain warranty service?

If you purchased the Product at a Best Buy or Future Shop retail store location, please take your original receipt and the Product to any Best Buy or Future Shop store. Make sure that you place the Product in its original packaging or packaging that provides the same amount of protection as the original packaging. If you purchased the Product from a Best Buy or Future Shop online web site (www.bestbuy.com, www.bestbuy.ca, or www.futureshop.ca), mail your original receipt and the Product to the address listed on the web site. Make sure that you put the Product in its original packaging or packaging that provides the same amount of protection as the original packaging.

To obtain warranty service, in the United States call 1-888-BESTBUY, Canada call 1-866-BESTBUY for Future Shop call 1-800-663-2275. Call agents may diagnose and correct the issue over the phone.

Where is the warranty valid?

This warranty is valid only in the United States and Canada at Best Buy or Future Shop branded retail stores or websites to the original purchaser of the product in the county where the original purchase was made.

What does the warranty not cover?

This warranty does not cover:

- Customer instruction/education
- Installation
- Set up adjustments
- Cosmetic damage
- Damage due to weather, lightning, and other acts of God, such as power surges
- Accidental damage
- Misuse
- Abuse
- Negligence
- Commercial purposes/use, including but not limited to use in a place of business or in communal areas of a multiple dwelling condominium or apartment complex, or otherwise used in a place of other than a private home.

- Modification of any part of the Product, including the antenna
- Display panel damaged by static (non-moving) images applied for lengthy periods (burn-in).
- Damage due to incorrect operation or maintenance
- Connection to an incorrect voltage or power supply
- Attempted repair by any person not authorized by Insignia to service the Product
- Products sold "as is" or "with all faults"
- Consumables, including but not limited to batteries (i.e. AA, AAA, C etc.)
- Products where the factory applied serial number has been altered or removed
- Loss or Theft of this product or any part of the product
- Display panels containing up to three (3) pixel failures (dots that are dark or incorrectly illuminated) grouped in an area smaller than one tenth (1/10) of the display size or up to five (5) pixel failures throughout the display. (Pixel based displays may contain a limited number of pixels that may not function normally.)
- Failures or Damage caused by any contact including but not limited to liquids, gels or pastes.

REPAIR REPLACEMENT AS PROVIDED UNDER THIS WARRANTY IS YOUR EXCLUSIVE REMEDY FOR BREACH OF WARRANTY. INSIGNIA SHALL NOT BE LIABLE FOR ANY INCIDENTAL OR CONSEQUENTIAL DAMAGES FOR THE BREACH OF ANY EXPRESS OR IMPLIED WARRANTY ON THIS PRODUCT, INCLUDING, BUT NOT LIMITED TO, LOST DATA, LOSS OF USE OF YOUR PRODUCT, LOST BUSINESS OR LOST PROFITS. INSIGNIA PRODUCTS MAKES NO OTHER EXPRESS WARRANTIES WITH RESPECT TO THE PRODUCT, ALL EXPRESS AND IMPLIED WARRANTIES FOR THE PRODUCT, INCLUDING, BUT NOT LIMITED TO, ANY IMPLIED WARRANTIES OF AND CONDITIONS OF MERCHANTABILITY AND FITNESS FOR A PARTICULAR PURPOSE, ARE LIMITED IN DURATION TO THE WARRANTY PERIOD SET FORTH ABOVE AND NO WARRANTIES, WHETHER EXPRESS OR IMPLIED, WILL APPLY AFTER THE WARRANTY PERIOD. SOME STATES, PROVINCES AND JURISDICTIONS DO NOT ALLOW LIMITATIONS ON HOW LONG AN IMPLIED WARRANTY LASTS, SO THE ABOVE LIMITATION MAY NOT APPLY TO YOU. THIS WARRANTY GIVES YOU SPECIFIC LEGAL RIGHTS, AND YOU MAY ALSO HAVE OTHER RIGHTS, WHICH VARY FROM STATE TO STATE OR PROVINCE TO PROVINCE.

Contact Insignia:

For customer service please call 1-877-467-4289
www.insigniaproducts.com

INSIGNIA is a trademark of Best Buy and its affiliated companies. Registered in some countries.

Distributed by Best Buy Purchasing, LLC
7601 Penn Ave South, Richfield, MN 55423 U.S.A.
©2014 Best Buy. All rights reserved.

Made in China

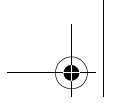

INSIGNIA™

QUICK-SETUP GLASS AND METAL TV STAND

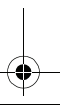
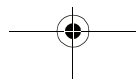
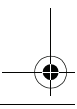
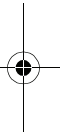
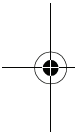



QUICK-SETUP GLASS AND METAL TV STAND

INSIGNIA™

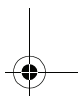
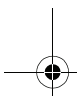
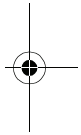
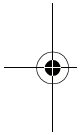

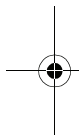

INSIGNIA™

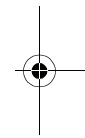

Certificate of Conformity

1. This certificate applies to the Insignia Product identified by this instruction booklet.
2. This certificate applies to the compliance of this product with the CPSC Ban on Lead-Containing Paint (16 CFR 1303).
3. This product was manufactured for:
Insignia

4. Date of Manufacture: _____

Lot number:

1-877-467-4289 (U.S. and Canada) or 01-800-926-3000 (Mexico)
www.insigniaproducts.com

INSIGNIA is a trademark of Best Buy and its affiliated companies.
Registered in some countries.
Distributed by Best Buy Purchasing, LLC
7601 Penn Ave South, Richfield, MN 55423 U.S.A.
©2014 Best Buy. All rights reserved.
Made in China

V2 ENGLISH
14-1390

